

SPECIFICATION SHEET



Photo



TECHNICAL DRAWING

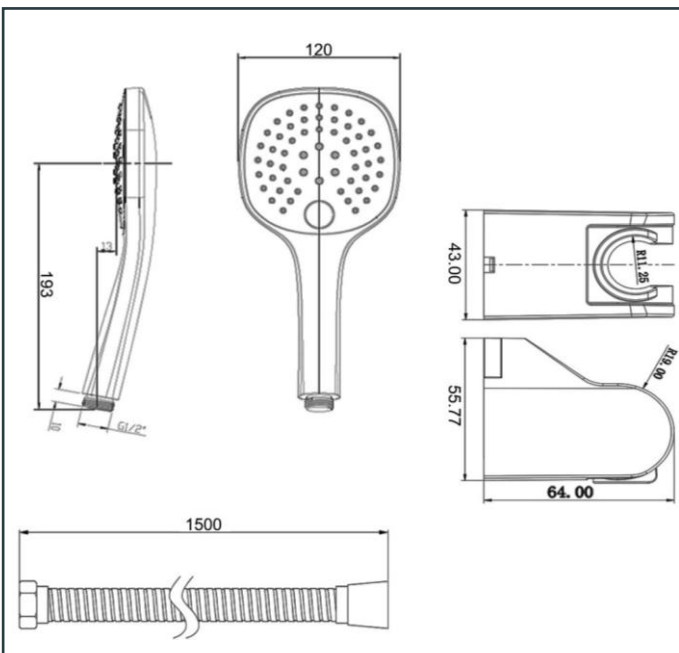

Product Information

Item Descriptions: Three options hand shower set with holder

Model: TS

Article No: TRS0020N

Material: Various Material

Brand: TREDEX

Finish: The colour / finish may vary on actual





Specifications:

3 options hand shower set, 1.5 m shower hose, with wall holder. With flow rate (at 3 bar) 5.98 l/min.

 **Eco-Mix**
Air-infused water provides a luxurious water experience while using lesser water.

 **Rain**
Comfortable water flow and even cover flow.

 **Massage**
Relaxing experience offering stress relief and improved circulation.

 **Rain - Massage**
Customizable luxurious shower experience for enhanced comfort & pain relief.

 **Quick Clean**
Enables manual limescale removal.

 **Switch**
Single click to desired jet type for a more enjoyable experience.